

40 Watts

- 85 to 305VAC input
- Single outputs from 3.3 to 48VDC
- PCB mount
- Encapsulated & open frame
- ITE & household appliance approvals
- EN55035 immunity standard
- Class II
- Low cost
- 3 year warranty

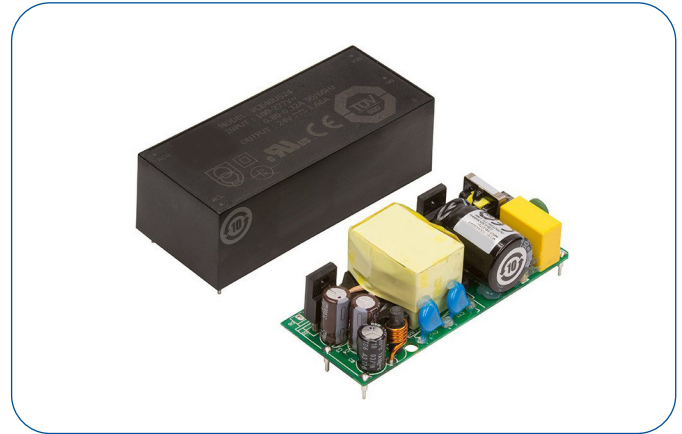

Dimensions:

VCE40:

3.46 x 1.50 x 1.12" (87.9 x 38.1 x 28.5 mm)

VCE40-P:

3.35 x 1.38 x 1.09" (85.0 x 35.1 x 27.7 mm)

The VCE40 is a series of open frame and encapsulated AC-DC single output power supplies designed for low cost ITE, industrial and domestic applications. The series provides two mechanical options including open frame and encapsulated PCB mount. With approvals to world-wide safety standards including ITE and Household, compliance with class B for conducted and radiated emissions, these class II isolation parts benefit system designers with easy integration into a wide range of applications.

Models & Ratings

Output Power	Output Voltage	Output Current	Model Number ⁽¹⁾
30 W	3.3VDC	9.10 A	VCE40US03
40 W	5.0VDC	8.00 A	VCE40US05
40 W	9.0VDC	4.44 A	VCE40US09
40 W	12.0VDC	3.33 A	VCE40US12
40 W	15.0VDC	2.66 A	VCE40US15
40 W	24.0VDC	1.66 A	VCE40US24
40 W	48.0VDC	0.82 A	VCE40US48

Notes

1. For Open Frame version add suffix -P to model number, e.g. VCE40US12-P.

Summary

Characteristic	Minimum	Typical	Maximum	Units	Notes & Conditions
Input Voltage Range	85		305	VAC	Derate output from 100% at 90 VAC to 90% at 85 VAC
No Load Input Power			0.3	W	
Efficiency		85		%	Model dependant
Operating Temperature	-25		+70	°C	3V3 & 5V models: derate output linearly from 100% at +45 °C to 45% at +70 °C. Other models: derate output linearly from 100% at 50 °C to 50% at 70 °C.
EMC	EN55032 Level B Conducted & Radiated, EN601000-3-2, EN61000-3-3, EN55024				
Safety Approvals	IEC62368-1, IEC60335-1, IEC60950-1, EN62368-1, EN60335-1, UL62368-1				

Input

Characteristic	Minimum	Typical	Maximum	Units	Notes & Conditions
Input Voltage Range	85		305	VAC	Derate from 100% at 90 VAC to 90% at 85 VAC
Input Frequency	47		63	Hz	
Input Current - Full Load		0.7/0.4		A rms	At 115/230 VAC
No Load Input Power			0.3	W	
Inrush Current			40	A	At 230 VAC, cold start 25 °C
Earth Leakage Current					Class II construction no earth
Input Protection	Internal T1.0 A/300 VAC fuse fitted in line				

Output

Characteristic	Minimum	Typical	Maximum	Units	Notes & Conditions
Output Voltage	3.3		48	VDC	
Initial Set Accuracy			1.5/1.0	%	1.5% for 3V3 & 5V models, 1% for others at 50% load
Minimum Load	0			A	No minimum load required
Line Regulation			1	%	
Load Regulation			2	%	
Start Up Delay			2	s	
Start Up Rise Time			35	ms	
Hold Up Time	8	14		ms	at full load and 115 VAC
Transient Response			4	%	Deviation, recovery within 1% in less than 500 μ s for a 25% load change
Ripple & Noise			100	mV pk-pk	3V3 & 5V models, 20 MHz bandwidth
				% pk-pk	9 to 48 V models, 20 MHz bandwidth
Overvoltage Protection	115		140	% Vnom	210% typical for 3V3 model, auto recovery
Overload Protection	110		190	%	
Short Circuit Protection					Trip & Restart (hiccup mode)
Temperature Coefficient			0.05	%/°C	

General

Characteristic	Minimum	Typical	Maximum	Units	Notes & Conditions
Efficiency		85		%	Model Dependant
Isolation: Input to Output	3000			VAC	
Switching Frequency	5		65	kHz	Varied with load
Power Density			7.7	W/in ³	For '-P' version
Mean Time Between Failure	550	600		kHrs	MIL-HDBK-217F, +25 °C GB
Weight		0.187 (85)		lb (g)	Open frame versions (-P)
		0.419 (190)		lb (g)	Encapsulated version

Efficiency Graphs

VCE40US12-P

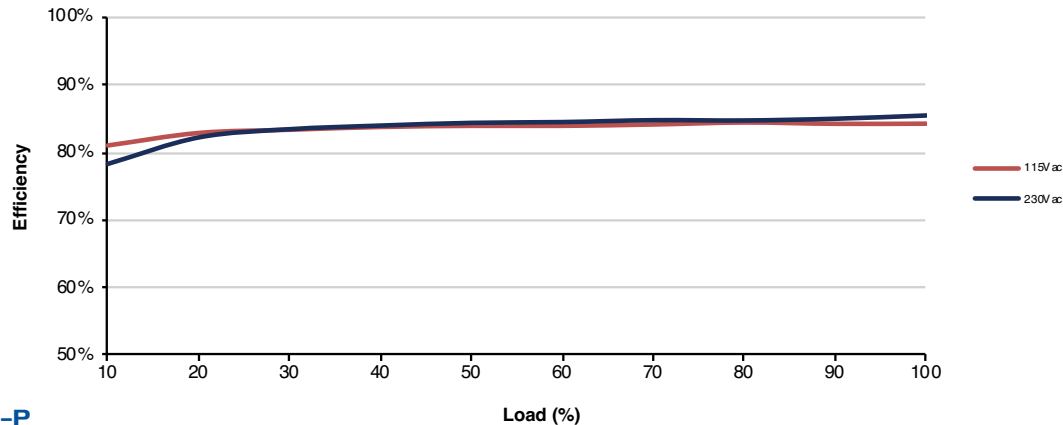

VCE40US24-P

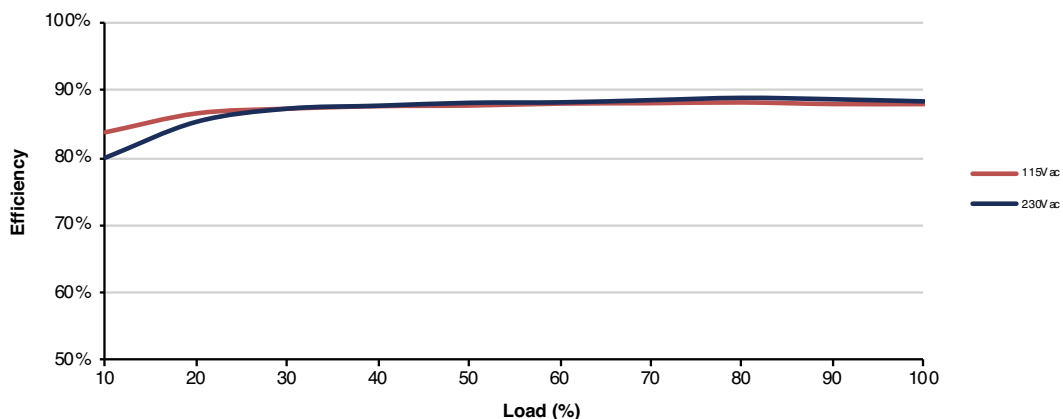

Environmental

Characteristic	Minimum	Typical	Maximum	Units	Notes & Conditions
Operating Temperature	-25		+70	°C	3V3 & 5V models: derate output linearly from 100% at +45 °C to 45% at +70 °C. Other models: derate output linearly from 100% at 50 °C to 50% at 70 °C.
Storage Temperature	-40		+85	°C	
Cooling					Convection-cooled
Humidity			95	%RH	Non-condensing
Operating Altitude			5000	m	
Shock	IEC68-2-27, 30 g, 11 ms half sine, 3 times in each of 6 axes				
Vibration	IEC68-2-6, 2 g, 10 Hz to 500 kHz, 10 mins/cycle, 60 mins each cycle				

EMC: Emissions

Phenomenon	Standard	Test Level	Criteria	Notes & Conditions
Conducted	EN55032	Class B		
Radiated	EN55032	Class B		
Harmonic Current	EN61000-3-2			Class A
Voltage Flicker	EN61000-3-3			

EMC: Immunity

Phenomenon	Standard	Test Level	Criteria	Notes & Conditions
ITE	EN55024 EN55035	As Below	As Below	
ESD	EN61000-4-2	±6kV contact, ±8kV air discharge	A	
Radiated	EN61000-4-3	10 V/m	A	
EFT	EN61000-4-4	3	A	
Surge	EN61000-4-5	2	A	Line to Line
Conducted	EN61000-4-6	10 Vrms	A	
Magnetic Fields	EN61000-4-8	30 A/m	A	
Dips and Interruptions	EN61000-4-11 (115 VAC)	70% U _r (80.5 VAC) for 100 ms	A	
		40% U _r (46 VAC) for 200 ms	B	
		<5% U _r (0 VAC) for 10 ms	A	
		<5% U _r (0 VAC) for 5000 ms	B	
	EN61000-4-11 (230 VAC)	70% U _r (161 VAC) for 100 ms	A	
		40% U _r (92 VAC) for 200 ms	A	
		<5% U _r (0 VAC) for 10 ms	A	
		<5% U _r (0 VAC) for 5000 ms	B	

Safety Approvals

Safety Agency	Safety Standard	Notes & Conditions
CB	IEC60950-1	ITE
	IEC62368-1	
	IEC60335-1	Household
UL	UL62368-1	ITE
TUV	EN62368-1	ITE

Mechanical Details

Encapsulated

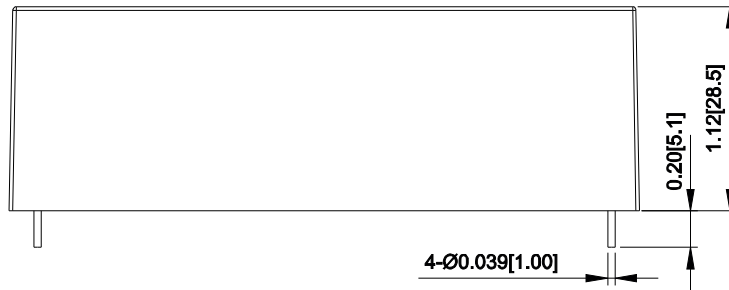
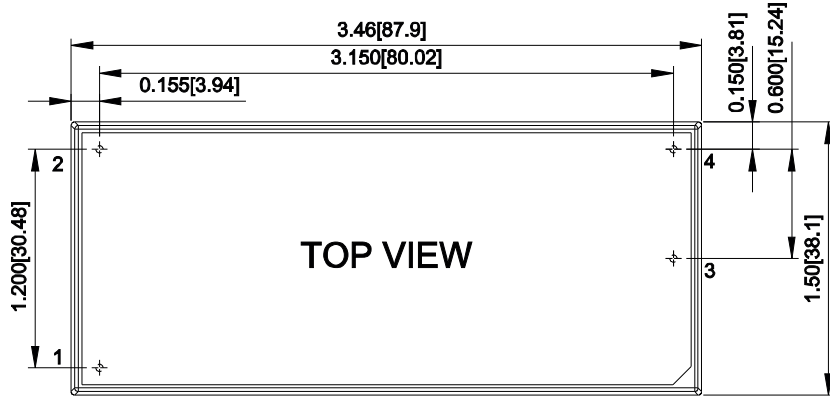

Open Frame (-P)

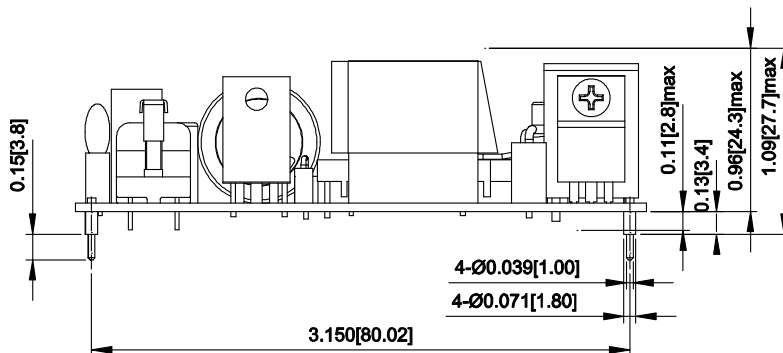
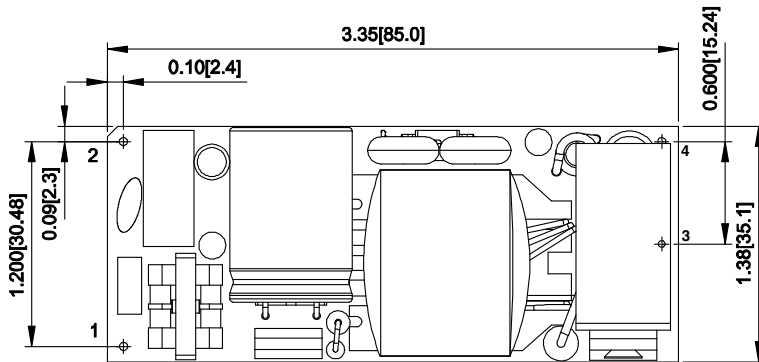

Pin Connections	
Pin	Single
1	ACL
2	ACN
3	-Vout
4	+Vout

Notes

- Dimensions in inches (mm).
- Weight: Open frame versions (-P): 0.187 lbs (85 g)
Encapsulated: 0.419 lbs (190 g)
- Tolerances: x.xx = ± 0.02 (x.x = ± 0.5)
x.xxx = ± 0.01 (x.xx = ± 0.25)